



# The pet company

## BRIFE INTRODUCTION

Once upon a time, there was a pet-loving entrepreneur named Rosanna Go who had a dream of creating a brand that would make pets' lives healthier and happier. She noticed that there was a gap in the market for high-quality, innovative pet products that were affordable for all pet owners.

With her passion for pets and her entrepreneurial spirit, Rosanna founded The Pet Company, a brand that would revolutionize the pet industry. The Pet Company was founded with the core belief that every pet deserves the best and that their health and comfort should be a top priority.

As The Pet Company grew, Rosanna continued to focus on developing new, innovative designs that would improve the lives of pets around the world. The company's commitment to quality and affordability quickly made it a household name, and pet owners everywhere began to recognize The Pet Company as a brand they could trust.

Over the years, The Pet Company has continued to expand its product line, offering a wide range of high-quality, innovative products that cater to pets of all shapes and sizes. From cozy beds to interactive toys, The Pet Company has everything pet owners need to keep their furry friends healthy, happy, and comfortable.

Today, The Pet Company is more than just a brand - it's a symbol of love and devotion to pets everywhere. Through its commitment to quality and innovation, The Pet Company has helped countless pets lead happier, healthier lives. And Rosanna Go, the founder, remains just as passionate about pets as she was on day one, continuing to drive the company forward with her unwavering dedication and love for animals.

# PRODUCT INTRODUCTION



Harness & collar & leashes



Comb & Bowls & Drinkers

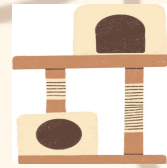
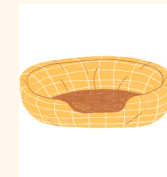

Bed & Cage & pet supplies

# The pet Company



## Keep Healthy

Pet bowls , slow feeder & electronic feeders provide pet a healthy habit and help you to meet a better life.

### **Pet bowls & bottles**

It is convenient for serving food and water. Keep pets healthy.

### **Pet carrier & crate**

Crate & kennel training is vital for dog safety & comfort.

### **Cat litter box & cat litter**

Provides your cat with privacy & keep clean



# The pet Company



## STAINLESS STEEL PET BOWLS

WATER AND FOOD BOWLS



- A Bowl of Two Use
- Skid-proof Design
- Removable Design For Easy Cleaning

**01**  
Stainless Steel  
Pet Bowls  
YE117411  
S:14X13X4CM  
M:18X17X6CM  
L:22X21X8CM



**02**  
Stainless Steel  
Pet Bowl  
YE117412  
28X17X5.5CM



**03**  
Slow Feeder  
Pet Bowl  
YE117413  
28X17X5.5CM



## HANGING PET CAGE BOWL

PERFECT FOOD BOWL &  
WATER BOWL FOR CRATE

- The bowl is easy to fix to the cage and remove, clean up, fill up.
- Perfect for small to large pets, puppy, kitten, dogs, cats, rabbits, squirrels



**05**  
Pet Crate Bowl  
YE117415  
S:15.5X13X5.5CM  
M:19X16.5X5.5CM



**06**  
Pet Crate Bowl  
YE117416  
S:14.5X14X6CM  
M:17X16.5X6CM





# The pet Company



HANGZHOU TIANYUAN PET PRODUCTS CO., LTD





# The pet Company



## PET SLOW FEEDER BOWL

ANTI-CHOKING  
ADJUST PET WEIGHT  
PREVENT INDIGESTION

*Promotes Fun & Healthy Diet*

The fun feeder slo-bowls promote healthy eating, swirl flower pattern design can slow down rapid eating and stop choking, adjust pet weight, prolonging meal time prevent indigestion, interactive and fun feeder. Eat slower eat healthier



**01**  
Pet Slow Feeder Bowl  
YE117425  
21X21X5.5CM



**02**  
Pet Slow Feeder Bowl  
YE117426  
21X21X5.5CM



**03**  
Pet Slow Feeder Bowl  
YE117427  
21X21X5.5CM



**04**  
Pet Slow Feeder Bowl  
YE117428  
23.5X26.5X5CM



## FEEDING NON-SLIP PET BOWL

PROMOTES HEALTHY DIET  
EASY USE & CLEAN  
NON-TOXIC



**05**  
Non-slip Pet Bowl  
YE117430

MATERIAL: PP; TPR  
S:17.5X17.5X5CM  
M: 21X21X6CM  
L:24X24X7CM



**06**  
Non-slip Pet Bowl  
YE117429  
MATERIAL: PP; TPR  
13.7X13X3.5CM



**07**  
Non-slip Slow Feeder  
YE117431  
MATERIAL: PP; TPR  
S:21X21X6CM  
L:24X24X7CM



**08**  
Non-slip Double Pet Bowl  
YE117432

MATERIAL: PP; TPR  
S:29X14.5X6CM  
M: 34.5X17.5X7.5CM  
L:39.5X20X8.5CM

# The pet Company



## WATER & FOOD FEEDER



PATENT NUMBER:  
CN202021077971.3  
DE20200118  
30X15.2X15CM

Product Name	Pet Water & Food Feeder
Item No.	DE20200118
Dimensions	30x15.2x15cm
Water Capacity	1L
Material	PP AS Silicone
Color	Nebulas Blue / Makino Green / Begonia Red



### Scientific feeding

The grain bowl is designed to be 15 cm above the floor. It helps protect the animal's spine and prevent choking from eating.

- Automatic Water Feeding
- Double Bowl Design
- Scientific feeding

### Three colors to choose

- Morandi contrasts colors
- Elegant in design



Package Size  
30.7x16x13.2cm

# The pet Company



**AUTOMATIC PET WATER DISPENSER**  
HEALTHY & SAFETY  
FREE-FALLING WATER STREAM



CAPACITY  
**2.4L**

## Purifying Circulation Filtration System

- It provides healthy, running and oxygen-enriched water for your pets.
- Free-falling stream entices pets to drink more water.
- Purify the water, remove the hair, dirt and food particles.



### Separate structure, easier to clean

- Take out the power supply before cleaning, and then can be cleaned separately.

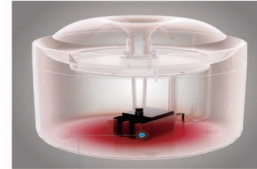
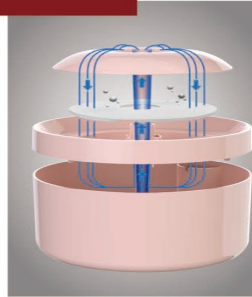

It detects low water level to avoid dry burning.

## Water Shortage Automatic Power-off

- The pump will shut off automatically, while the water storage level is too low.

## USB Charging



- The water dispenser powered with USB cable (adapter not included).
- It can connect all USB charging equipment. It is very convenience.



## AUTOMATIC PET WATER DISPENSER

### QUIET & COMFORTABLE SLEEP

It works super quiet! No worries of disturbing you and your pets rest. You will only hear soft sound of natural water flowing.



DE2020115-A  
Pink



DE2020115-B  
White

Product Name: Automatic Pet Water Dispenser  
Item No.: DE2020115  
Dimensions: 20x20x17cm  
Water Capacity: 2.4L  
Material: ABS+Silicone  
Color: Pink / White



## PRODUCT FEATURES



Oxygen Cycle



Quiet Operation



Water Shortage Protection



USB Charging Cable



Replaceable Filter

**PATENT NUMBER:CN202030156821.0**

Automatic Pet  
Water Dispenser  
DE2020115  
20X20X17CM



# The pet Company



## KEEP FRESH AUTOMATIC FEEDING BOWL



### AUTOMATIC SWITCH BOWL COVER

Maximum induction distance: 40cm  
Detection angle: 120°

Requires 4 xAA batteries  
(not included)



## SMART INDUCTION FRESH-KEEPING PET FEEDING BOWL



Intelligent Opening



Precise Induction



Fresh-Keeping



Removable  
Steel Bowl



### INFRARED SENSING TECHNOLOGY

When pets enter the sensing range, the lid of the pet feeding bowl will open automatically, and it will remain open for 5 minutes. After 5 minutes, if it is judged that the pet has left, it will automatically shut down after 30 seconds.

Infrared  
Sensing

Capacity  
400ML



Removable 304  
steel bowl for  
easy cleaning  
and health.



360° sealed and  
fresh-keeping locks  
nutrition to ensure  
health.

# The pet Company

**6 MEALS AUTOMATIC PET FEEDER**

**1-6 Meals Per Day**

**Smart Digital Touch Panel**

**Anti-seize Function**

**PATENT PENDING**

\* Images are for illustration only. Colours may vary.



98 05.PET DAILY-USE

DE116471  
31.5X31.5X8.3CM  
HANGZHOU TIANYUAN PET PRODUCTS CO., LTD

## 6 Isolated Portions for Wet and Dry Food



## Easy to Disassemble & Clean

Wash it regularly to make your pet's diet more hygienic



Each compartment can hold up to 180ml (about 90g) of food.



Allows ice packs in to keep wet and dry food fresh.

## Smart Digital Touch Panel With Screen off function



## Anti-seize Function

When pet's enter into the storage tray, the cover will rotate back before next rotation.



## Display Locking Design

With the display locking design, your pets cannot change or interrupt your settings when they are curious about the feeder.



05.PET DAILY-USE

99

# The pet Company



FEEDING



货号 ITEM NO	BP186
品名 DESCRIPTION	喂水器
尺寸 SIZE	27*20*43cm
材质 MATERIAL	PP/透苯/金属

## Liftable

Adjustable heights , drinking comfortably .

## 可升降

高度可调节, 舒适饮水

## nuzzle ball design

Gently lick the water without leaking.

## 水嘴滚珠设计

轻舔出水, 不漏水



Color choice / 颜色多选

# The pet Company

FEEDING



货号 ITEM NO	BP119
品名 DESCRIPTION	喂食器
尺寸 SIZE	36.5*31.5*38cm
材质 MATERIAL	PP

货号 ITEM NO	BP187
品名 DESCRIPTION	喂食器
尺寸 SIZE	26*16*26cm
材质 MATERIAL	PP



# The pet Company



## FEEDING



货号 ITEM NO	BP133
品名 DESCRIPTION	双鱼碗
尺寸 SIZE	30.5*16.5*5.5cm
材质 MATERIAL	PP



货号 ITEM NO	BP115
品名 DESCRIPTION	防滑狗碗
尺寸 SIZE	26*20*7.5cm
材质 MATERIAL	PP



货号 ITEM NO	BP112
品名 DESCRIPTION	防滑宠物碗 小号
尺寸 SIZE	Φ15*11*5.5cm
材质 MATERIAL	PP



货号 ITEM NO	BP178
品名 DESCRIPTION	小号双碗
尺寸 SIZE	20.1*35.7*9.3cm
材质 MATERIAL	ABS/PP/PC

货号 ITEM NO	BP114
品名 DESCRIPTION	防滑双狗碗
尺寸 SIZE	26.5*16*5cm
材质 MATERIAL	PP



# The pet Company



## FEEDING

### FEEDING

货号 ITEM NO	BP113
品名 DESCRIPTION	小号防蚊双狗碗
尺寸 SIZE	27.5*15.5*3.2cm
材质 MATERIAL	PP

货号 ITEM NO	BP113-1
品名 DESCRIPTION	大号防蚊双狗碗
尺寸 SIZE	37*20*5.5cm
材质 MATERIAL	PP



货号 ITEM NO	BP123
品名 DESCRIPTION	小号苹果碗
尺寸 SIZE	15.8*17*5cm
材质 MATERIAL	PP



货号 ITEM NO	BP124
品名 DESCRIPTION	中号苹果碗
尺寸 SIZE	21.2*19.5*6.3cm
材质 MATERIAL	PP



Color choice / 颜色多选



货号 ITEM NO	BP150
品名 DESCRIPTION	双狗碗
尺寸 SIZE	26.5*16.5*4.3cm
材质 MATERIAL	PP



货号 ITEM NO	BP176
品名 DESCRIPTION	八字形双碗
尺寸 SIZE	21.2*35*9cm
材质 MATERIAL	PP/ABS/PC

# The pet Company



FEEDING

Color choice / 颜色多选



货号 ITEM NO	BP245
品名 DESCRIPTION	光板碗 小号
尺寸 SIZE	Φ15.8*6cm
材质 MATERIAL	ABS/PP/PC

货号 ITEM NO	BP246
品名 DESCRIPTION	光板碗 中号
尺寸 SIZE	Φ19*7cm
材质 MATERIAL	ABS/PP/PC

货号 ITEM NO	BP247
品名 DESCRIPTION	光板碗 大号
尺寸 SIZE	Φ23*8.8cm
材质 MATERIAL	ABS/PP/PC



货号 ITEM NO	BP261
品名 DESCRIPTION	高架碗 小号
尺寸 SIZE	Φ19.2*13.8cm
材质 MATERIAL	PP/ABS/PC



货号 ITEM NO	BP242
品名 DESCRIPTION	条纹碗 小号
尺寸 SIZE	Φ17.5*6cm
材质 MATERIAL	PP/ABS/PC



货号 ITEM NO	BP211
品名 DESCRIPTION	钻石碗 小号
尺寸 SIZE	Φ16.4*5.6cm
材质 MATERIAL	PP/ABS/PC



货号 ITEM NO	BP213
品名 DESCRIPTION	长形架子碗 小号
尺寸 SIZE	25.7*14.5*10.5cm
材质 MATERIAL	PP/ABS/PC



货号 ITEM NO	BP262
品名 DESCRIPTION	高架碗 中号
尺寸 SIZE	Φ22.7*16.3cm
材质 MATERIAL	PP/ABS/PC



货号 ITEM NO	BP243
品名 DESCRIPTION	条纹碗 中号
尺寸 SIZE	Φ20.7*7cm
材质 MATERIAL	PP/ABS/PC



货号 ITEM NO	BP212
品名 DESCRIPTION	钻石碗 中号
尺寸 SIZE	Φ19.2*6.6cm
材质 MATERIAL	PP/ABS/PC

货号 ITEM NO	BP214
品名 DESCRIPTION	长形架子碗 中号
尺寸 SIZE	28.7*17.7*11.6cm
材质 MATERIAL	PP/ABS/PC



货号 ITEM NO	BP263
品名 DESCRIPTION	高架碗 大号
尺寸 SIZE	Φ27.6*20cm
材质 MATERIAL	PP/ABS/PC



Color choice / 颜色多选	● ●
---------------------	-----



Color choice / 颜色多选	● ●
---------------------	-----

货号 ITEM NO	BP215
品名 DESCRIPTION	长形架子碗 大号
尺寸 SIZE	34.5*22.5*12.2cm
材质 MATERIAL	PP/ABS/PC

# The pet Company



FEEDING

## The shape is novel

Shaped like a pumpkin, novel and suitable.

## 造型新颖

形状似南瓜, 新颖百搭

## Multiple sizes

Multiple sizes , suitable for dogs.

## 多种尺寸

多个尺寸适用于小、中、大型犬



货号 ITEM NO	BP125
品名 DESCRIPTION	小号南瓜碗
尺寸 SIZE	18*18*5.2cm
材质 MATERIAL	PP



货号 ITEM NO	BP126
品名 DESCRIPTION	中号南瓜碗
尺寸 SIZE	21*21*6.4cm
材质 MATERIAL	PP



货号 ITEM NO	BP127
品名 DESCRIPTION	大号南瓜碗
尺寸 SIZE	27.5*27.5*8.1cm
材质 MATERIAL	PP

货号 ITEM NO	BP128
品名 DESCRIPTION	特大号南瓜碗
尺寸 SIZE	37*37*11cm
材质 MATERIAL	PP



Color choice / 颜色多选

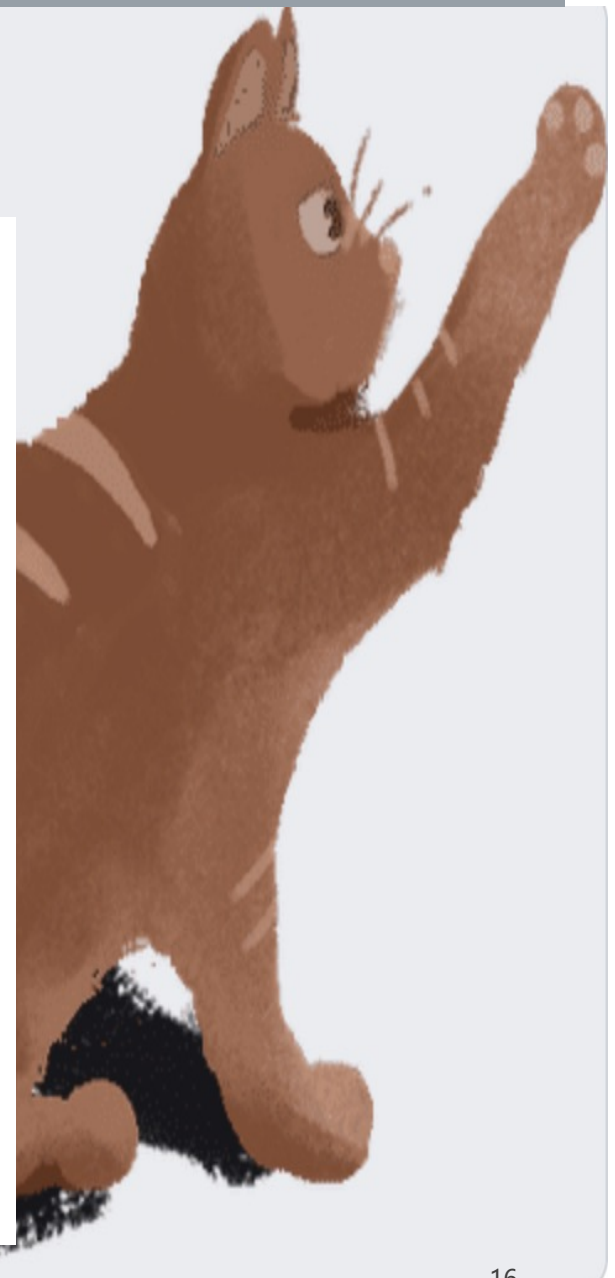
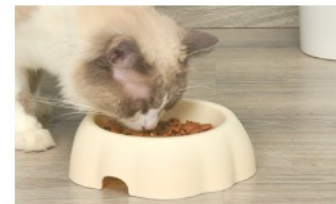



# The pet Company



## FEEDING



货号 ITEM NO	BP140
品名 DESCRIPTION	小号防噎狗碗
尺寸 SIZE	20*17.5*6cm
材质 MATERIAL	PP

### Anti-choke design

Pets eat slowly , prevent choking & vomiting.

### 防噎柱设计

缓慢进食,防噎防吐



货号 ITEM NO	BP141
品名 DESCRIPTION	大号防噎狗碗
尺寸 SIZE	30*26*8.8cm
材质 MATERIAL	PP

### Care for health

Eating scientifically, accompanied healthy.

### 呵护健康

科学进食,健康相伴

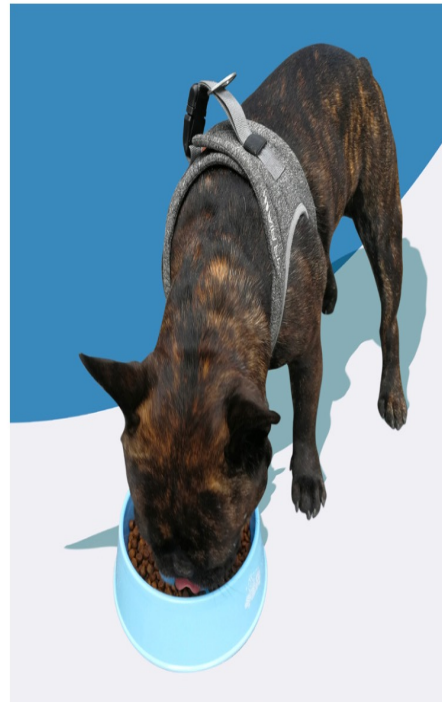

## FEEDING



货号 ITEM NO	BP116
品名 DESCRIPTION	防滑宠物碗 小号
尺寸 SIZE	21*16*10cm
材质 MATERIAL	PP



货号 ITEM NO	BP138
品名 DESCRIPTION	防滑宠物碗 大号
尺寸 SIZE	27*20*13.5cm
材质 MATERIAL	PP

货号 ITEM NO	BP110
品名 DESCRIPTION	大狗碗
尺寸 SIZE	26*20*7.5cm
材质 MATERIAL	PP



货号 ITEM NO	BP182
品名 DESCRIPTION	喂食饮水两用碗
尺寸 SIZE	23*23*8.5cm
材质 MATERIAL	PP/PE

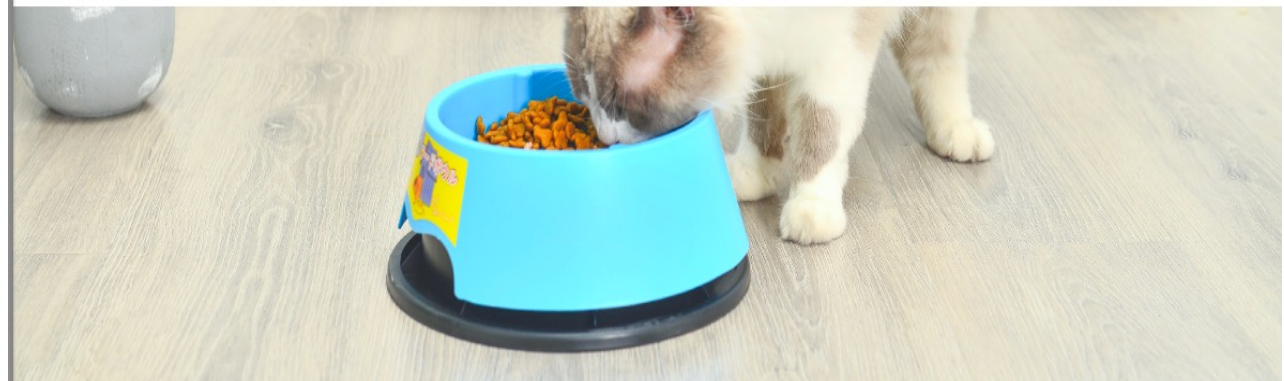

# The pet Company



货号 ITEM NO	BP185
品名 DESCRIPTION	量杯
尺寸 SIZE	10.8*7.8*9.5cm
材质 MATERIAL	PS



货号 ITEM NO	BP281
品名 DESCRIPTION	旅行水壶250ml
尺寸 SIZE	19*6.5*4.5cm
材质 MATERIAL	PP/不锈钢



货号 ITEM NO	BP132
品名 DESCRIPTION	挂式食盆/水碗
尺寸 SIZE	14.7*13.1*6cm
材质 MATERIAL	PP



货号 ITEM NO	BP189
品名 DESCRIPTION	水壶500ML
尺寸 SIZE	500ML
材质 MATERIAL	PP



货号 ITEM NO	BP188
品名 DESCRIPTION	狗粮勺
尺寸 SIZE	18*9*5.5cm
材质 MATERIAL	PP



货号 ITEM NO	BP134
品名 DESCRIPTION	挂式食碗 小号
尺寸 SIZE	12*9.5*9cm
材质 MATERIAL	HIPS改苯



货号 ITEM NO	BP144
品名 DESCRIPTION	挂式食碗 大号
尺寸 SIZE	15*12*12cm
材质 MATERIAL	HIPS改苯



# The pet Company



货号 ITEM NO	BP108
品名 DESCRIPTION	奶瓶
尺寸 SIZE	11.5*4*2.3cm
材质 MATERIAL	PP

## FEEDING



货号 ITEM NO	BP288
品名 DESCRIPTION	扁水壶小号250ML
尺寸 SIZE	12*8.8*4.5cm
材质 MATERIAL	PP/金属

货号 ITEM NO	BP289
品名 DESCRIPTION	扁水壶大号500ML
尺寸 SIZE	15*10*5.5cm
材质 MATERIAL	PP/金属



货号 ITEM NO	BP180
品名 DESCRIPTION	宠物饮水头-带瓶 小号
尺寸 SIZE	9.9*8.3*5.8cm
材质 MATERIAL	PP/PE/不锈钢

货号 ITEM NO	BP280
品名 DESCRIPTION	宠物饮水头-无瓶 大号
尺寸 SIZE	10.8*8.4*5.8cm
材质 MATERIAL	PP/PE/不锈钢

货号 ITEM NO	BP280-1
品名 DESCRIPTION	宠物饮水头-带瓶 大号
尺寸 SIZE	10.8*8.4*5.8cm
材质 MATERIAL	PP/PE/不锈钢

# The pet Company



carton spec/dimension

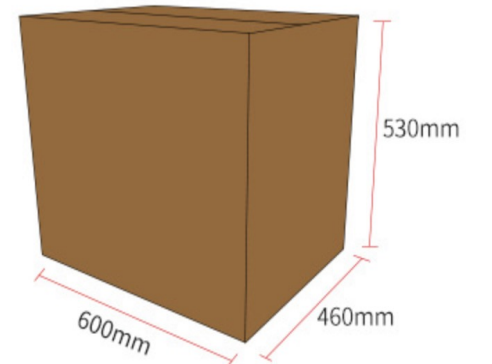
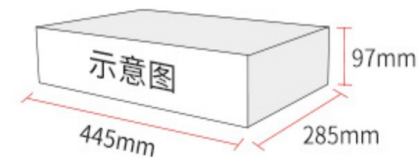

# The pet Company



调节锁扣孔

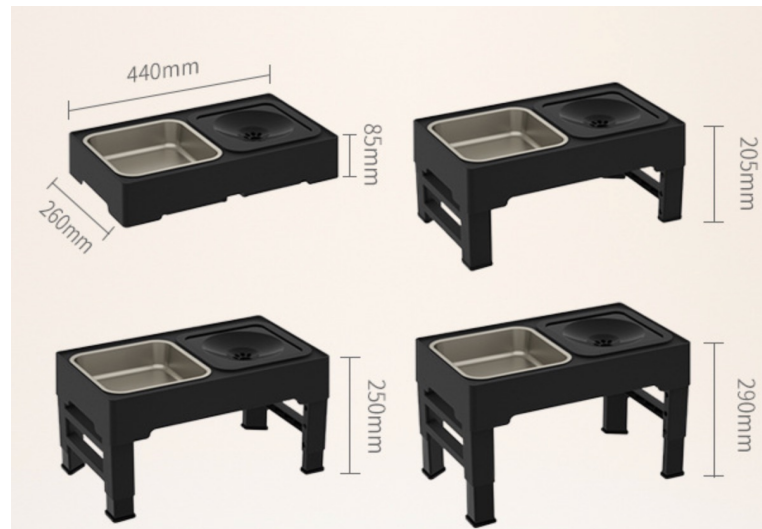

# The pet Company



*Curved water bowl fits the natural way of drinking water in dogs' mouths*

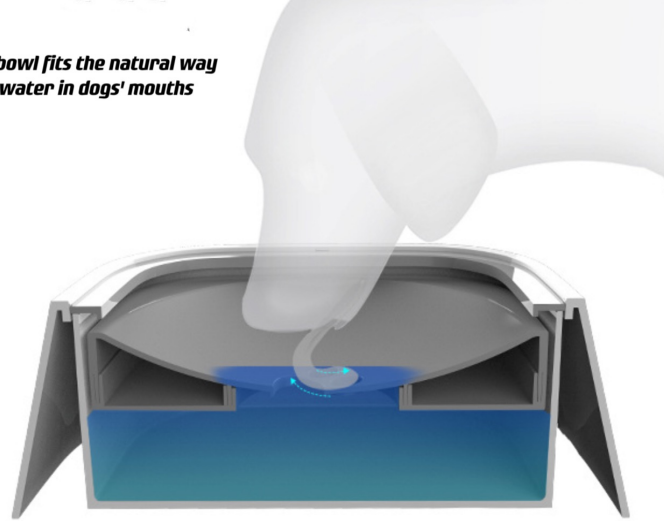

Claw shaped water outlet design for a lighter, healthier drink

Filter impurities with filter element



## ABS

High quality materials

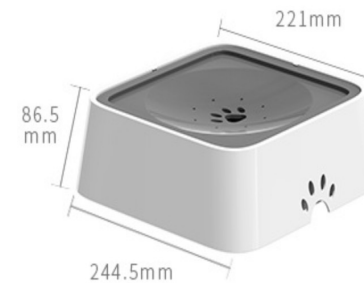

Item name : Pet floating water bowl

color : gray&white

weight : 735g

capacity : 2L

material : ABS & PP

# The pet Company

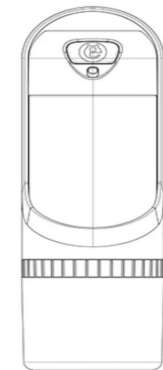

300ml (water) +100ml(food)

# The pet Company

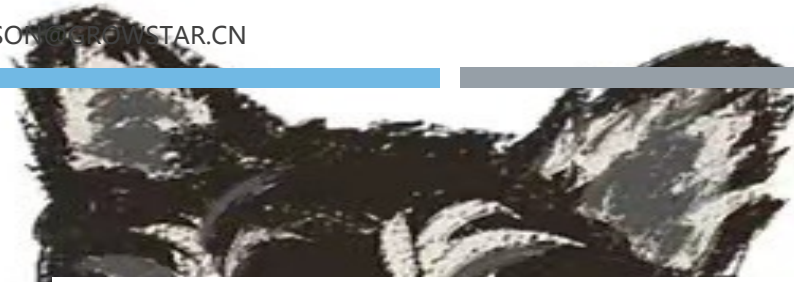

**No moisture & No bug**  
**Tightly integrated, isolate pollution**  
**ITEM NO GLT013**  
**DESCRIPTION BUCKET(15KG)**  
**SIZE 40.5\*30\*48.5cm**  
**MATERIAL PP**



**ITEM NO GLT001**  
**DESCRIPTION BUCKET(20kg)**  
**SIZE 44\*35\*48cm**  
**MATERIAL PP**

**ITEM NO GLT001**  
**DESCRIPTION BUCKET(12kg)**  
**SIZE 44\*35\*48cm**  
**MATERIAL PP**

**ITEM NO GLT001**  
**DESCRIPTION BUCKET(15kg)**  
**SIZE 44\*35\*48cm**  
**MATERIAL PP**

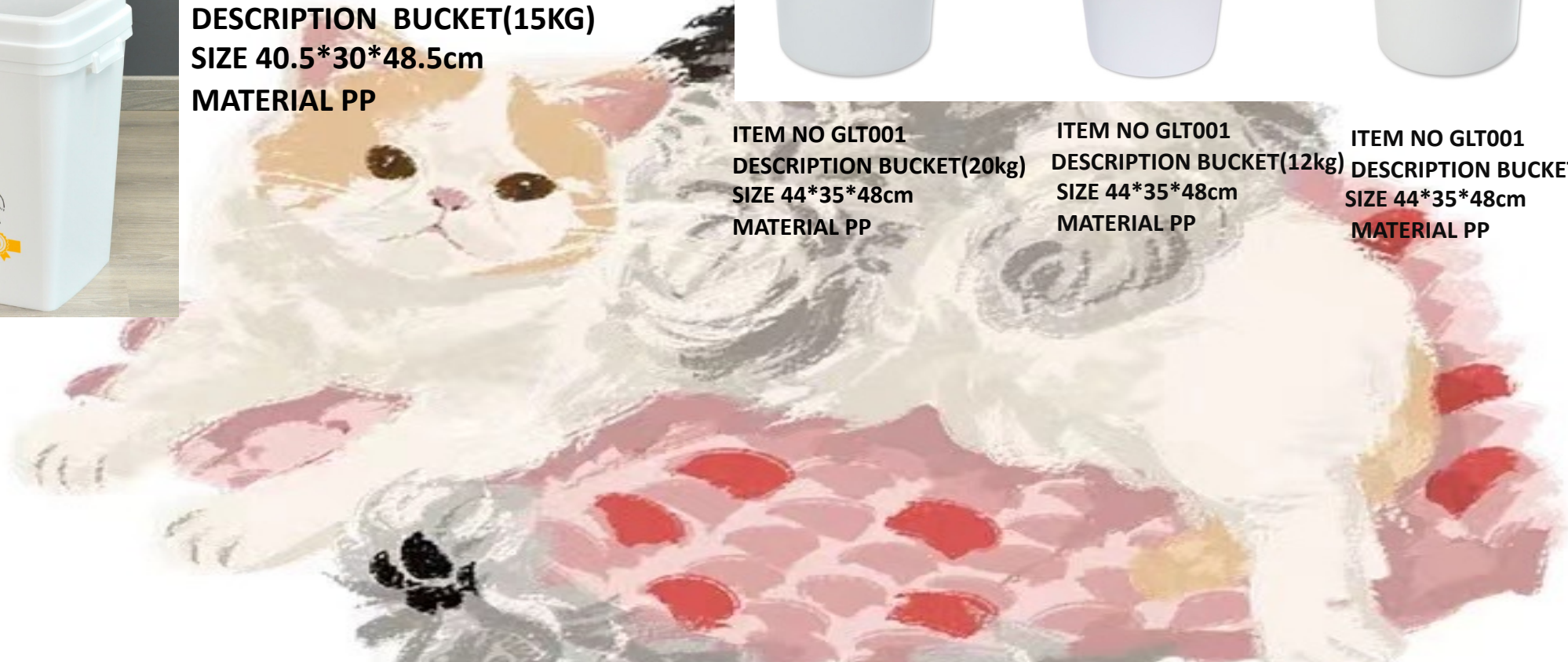



# The pet Company



Sealing rubber ring  
Strictly sealed, no moisture no dust  
Easy access to food  
Snap switch, easy to operate

ITEM NO GLT008  
DESCRIPTION BUCKET (3KG/8L)  
SIZE 26\*21.5\*27.5cm  
MATERIAL PP

ITEM NO GLT009  
DESCRIPTION BUCKET(5KG/14L)  
SIZE 32\*26.5\*34.5cm  
MATERIAL PP



ITEM NO GLT004  
DESCRIPTION BUCKET(15kg)  
SIZE 47.5\*31\*52cm  
MATERIAL PP

# The pet Company



ITEM NO BP149  
DESCRIPTION BUCKET(4kg)  
SIZE 36\*22\*25cm  
MATERIAL PP



ITEM NO GLT007  
DESCRIPTION BUCKET(10kg)  
SIZE 41\*28.5\*41cm  
MATERIAL PP



ITEM NO GLT002  
DESCRIPTION BUCKET(10kg)  
SIZE 38\*30\*35cm  
MATERIAL PP



ITEM NO BP146  
DESCRIPTION BUCKET(7.5kg)  
SIZE 33.4\*32.7\*32.5cm  
MATERIAL PP



ITEM NO BP145  
DESCRIPTION BUCKET(5kg)  
SIZE 27.5\*23\*28.5cm  
MATERIAL PP